

Technical Specifications / Instructions for Suppliers

Technical specifications

This document provides a detailed explanation of the specifications which are used in the technical documents (drawings, specs.) and which are required for the most important procedures. This ensures that all Oerlikon Balzers products meet the requirements for workmanship and packaging.

Compliance with these specifications is a prerequisite for meeting the high levels of quality demanded by our customers.

Changes

Revision No.	Reason for change	Name	Date
0	Initial release	Gerhard Bigger	06-06-08
1	Chapter 1 updated, Welding technology specifications added, Cleaning chapter 4	Gerhard Bigger	08-11-16
2	Formatting	Kim Schöll	21-02-18
3	Added Chapter 6 "Mounting for vacuum use"	Kim Schöll on behalf of Michael Wirth	21-03-18
4	Added Chapter Colour Coatings and Alternative Materials to drawing specifications	Dominik Widmer	23-07-20

Technical Specifications / Instructions for Suppliers

Conent

1	Validity / Release of drawings	4
2	Colour coatings	4
2.1	General information	4
2.2	Drawing specifications	5
2.2.1	Examples	6
2.2.2	Non-coated parts	7
2.2.3	Surface specifications for the substrate.....	7
2.3	Colour coatings (Examples)	7
2.4	Quality details	8
2.4.1	Primer	8
2.4.2	Topcoat	8
2.4.3	Surface texture	8
2.4.4	Degree of gloss.....	8
2.4.5	Chemical resistance	8
3	Alternative materials to drawing specifications	9
4	Tumbling / vibratory grinding	9
4.1	Purpose and field of application	9
4.2	Tumbling / vibratory grinding requirements	9
4.3	Specifications in the documents	10
5	Sandblasting	10
5.1	Purpose and field of application	10
5.2	Sandblasting requirements	10
5.3	Specifications in the documents	10
5.4	Process specifications	10
6	Welding	12
6.1	Purpose and field of application	12
6.2	Welding process specification (reference number)	12
6.3	Welding requirements.....	12
6.3.1	Class 1: General specifications	12
6.3.2	Class 2: Products with higher welding process quality requirements	12
6.3.3	Class 3: Specifications for load-lifting equipment.....	13
7	Cleaning	13
7.1	Purpose and field of application	13
7.2	Cleaning requirements.....	13
7.2.1	a) General cleaning class	13
7.2.2	b) Cleaning process parts.....	13
7.3	Specifications in the drawings	14
7.4	Process specifications	14
8	Mounting for vacuum use	14
8.1	Purpose and field of application	14

Technical Specifications / Instructions for Suppliers

8.2 Mounting requirements 14

8.3 Specifications in the drawing 14

8.4 Mounting specifications 15

9 Bake-out 15

9.1 Purpose and field of application 15

9.2 Specifications in the documents 15

9.3 Bake out process 15

10 Packaging 15

10.1 References to further specification documents 16

Technical Specifications / Instructions for Suppliers

1 Validity / Release of drawings

An overview of the most important information on drawings:

Kantenbruch / Edges with undefined shape falls nicht anders angegeben / unless otherwise stated		-0.05 -0.2	+0.2 +0.05	ISO 13715	Allgemeintoleranz / General tolerance ISO 2768 - mK	Tolerierung / Tolerancing ISO 8015
Werkstoff / Material 1.4301 X5CrNi18-10		Mass / Size ISO 14405		Oberfläche / Surface ISO 1302		
Massstab / Scale 5 : 1	Projektion / Projection 	Gewicht / Weight 0.01 kg	Blatt / Sheet 1	Blätter / Sheets 1	vertraulich / confidential	
 Beispielteil Sample part		Erstellt / Created 07.09.16	li_hupa		In Work	
		Dokument Nummer / Document Number 80124026		Doc. Version A.1		
80124026 A.1		07.09.2016 16:04 li_hupa		CC-Class: BB	Part-No.: 2029335 A.1	

Data that has been released for production has “Released” or “Prototype” part status, “Released” document status and a footer with the information from the portal. If there is no entry in the area provided for the part status, this means that the part has “Released” status. All other part statuses are visible on the drawing.

For drawings created before June 2008, the document status can be blank or show the entry “Prototype.” Drawings like these are nonetheless released for production, provided that the part status is “Released” and the footer is present.

Contact the relevant Oerlikon Balzers purchaser immediately if you notice any irregularities.

2 Colour coatings

2.1 General information

This specification only covers production-neutral details, in particular the colour shade and, where necessary, textural and quality details. Normally, the coating method (e.g. wet painting or powder coating), the raw materials, the pre-treatment and the specification of processing instructions are left for the supplier to decide. The general environmental regulations of the country in which the painting takes place must be observed.

The colour specification is in two parts:

- Drawing specifications according to section 2.2 with surface texture
- Colour code and colour written out

This specification replaces the Balzers standard B0734 101.

Print-out for information only!

Technical Specifications / Instructions for Suppliers

2.2 Drawing specifications

Colour coatings are specified in the individual part drawing if the workpieces are to be coated with paint before assembly.

- Non-detachable assemblies (BB-X) can be treated as individual part drawings.
- Colour specifications in assembly drawings (BB-T) are not permitted.

Name of a colour coating:

[beschichtete Oberfläche]

[Farbcode] [Farbe] / [Oberflächenstruktur] / [Glanzgrad]

- | | | |
|----|--------------------------|--|
| a) | [Coated surface] | For application examples, see section 2.2.1 |
| b) | [Colour code] | Colour according to colour catalogue, e.g. RAL 7035
<i>for more information see section 2.4</i> |
| c) | [Colour] | Colour name according to colour catalogue from b)
<i>for more information see section 2.4</i> |
| d) | [Surface texture] | coarse
fine
medium fine
<i>for more information see section 2.4.3</i> |
| e) | [Degree of gloss] | silk gloss
(silk) matt
<i>for more information see section 2.4.4</i> |

Technical Specifications / Instructions for Suppliers

2.2.1 Examples

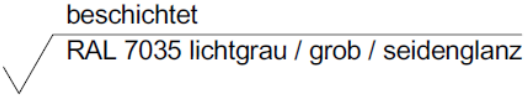
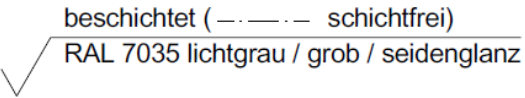
Symbol	Meaning
	Full coating
	Dash-dotted areas are not coated Additional information on marked component: see further examples.

Further examples:

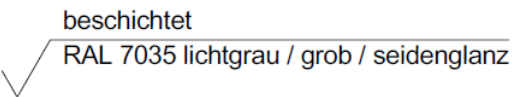

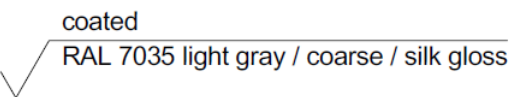

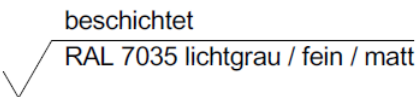

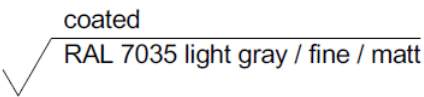

“Not coated” specification on drawing (earth connector used as an example):

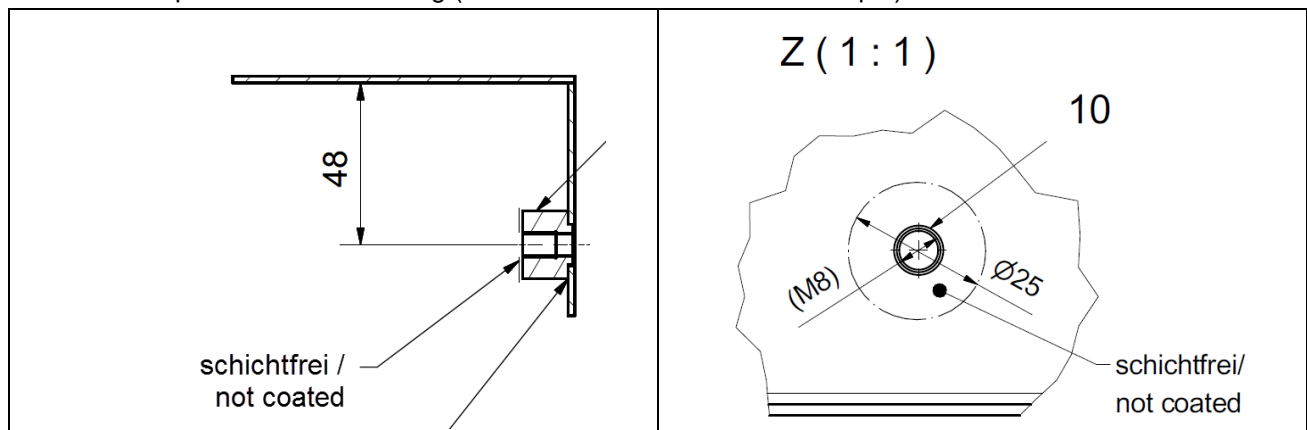

Technical Specifications / Instructions for Suppliers

2.2.2 Non-coated parts

If not specified in the drawing, internal and external threads are never coated.

The absence of coatings on threads is always noted in plain text on the drawing:

Thread not coated.

2.2.3 Surface specifications for the substrate

For standard colour surfaces, the roughness of mechanically treated surfaces should not exceed Ra 6.3. Cutting edges on sheet metal should not exceed Ra 12.5.

For untreated surfaces with surface roughness > Ra 6.3, the surface texture may differ from the specification in section 2.4.3!

2.3 Colour coatings (Examples)

Colour code ¹	Colour name	Texture	Degree of gloss	Application	Colour chart part no.
RAL 1018	Zinc yellow	coarse	silk gloss	Marking danger zones Lifting and hoisting equipment	5021930 (2045937)
RAL 2002	Vermilion	coarse	silk gloss	Mechanical hazard zones (e.g. rotating shafts), covers	5021929 (2049540)
RAL 7021	Black grey	coarse	silk gloss	“Black” of Oerlikon systems (base frames)	5021936 (2045941)
RAL 7021	Black grey	fine	matt	“Black” of Oerlikon systems (casing parts above base frames), control elements	5021934 (2045939)
RAL 7035	Light grey	coarse	silk gloss	“White” of Oerlikon systems Component and grey room areas, casing, rack cabinets	5021932 (2045938)
RAL 7035	Light grey	fine	matt	Front panels for electrical devices	5021931 (2045933)
RAL 3020	Traffic red	fine	matt	“Red” of Oerlikon systems (labels)	5021928 (2045929)
RAL 3020	Traffic red	fine	silk gloss	“Red” of Oerlikon systems for design elements on systems (stripes on doors)	5021927 (2049534)
RAL 9005	Jet black	coarse	silk gloss	Rough texture for uneven surfaces	5021935 (2045932)
RAL 9011	Graphite black	fine	matt	Optical devices, low-reflection surfaces	5021933 (2049536)
RAL 9006	White aluminium	fine	matt	Not used	1515416

¹ As standard, the RAL colour number is to be used. Alternatively, other colour systems can be used.

Technical Specifications / Instructions for Suppliers

RAL 9006	White aluminium	coarse	silk gloss	Back of screens / back of door handles RS50 (no longer to be used)	1515413
RAL 5002	Ultramarine blue	coarse	silk gloss	Not used	5019852 (2045935)

2.4 Quality details

2.4.1 Primer

- The primer must be nitro-resistant (no blistering when recoated with topcoat).
- The primer must be bakeable at 180°C.

2.4.2 Topcoat

When requested by customers, it must be possible to apply topcoats in standard colour shades. So the requirements for further processing are the same as for priming.

- The topcoat must be nitro-resistant.
- The topcoat must be bakeable at 180°C.

2.4.3 Surface texture

Sample panels (see section 2.3) are available for suppliers to determine the texture. The following surface textures are defined:

Coarse (orange peel)

- Slight waviness (according to colour chart part number 5021936)
- There must be no sharp-edged objects, so that the cleaning cloths do not become entangled
- Dust adhesion must be minimal

Fine

- No visible waviness, surface optically as smooth as possible (according to colour chart part number 5021934)

Medium fine

- Special texture for screen printing substrates
- Texture between rough and fine

2.4.4 Degree of gloss

Sample panels (see section 2.3) are available for suppliers to determine the degree of gloss. The following degrees of gloss are defined:

Silk gloss

- Silk gloss, DIN EN ISO 2813 40-80 GU/60°

Matt

- Silk matt, DIN EN ISO 2813 5-30 GU/60°

2.4.5 Chemical resistance

The topcoat must be resistant to common cleaning agents. Good resistance to the following solvents is also required:

- Acetone (propan2-one)

Technical Specifications / Instructions for Suppliers

- Isopropanol (Propan2-ol)
- Alcohol (ethanol)
- Cleaning thinners
- Chloroethane
- Isooctane (2,2,4-trimethylpentane) / Toluene (methylbenzene)

3 Alternative materials to drawing specifications

Oerlikon Balzers always indicates the material name on the drawings in accordance with the EN standard. The table below gives an overview of permitted alternative materials in accordance with other standards. The material used must be traceable in the delivery documents. If no alternative is listed in the relevant standard, a potential alternative material must be tested with Oerlikon on a case-by-case basis. In principle, the materials according to EN standards are preferred.

OERLIKON SPECS EN standard		Alternative material	
Material no.	Short name	AISI/ASTM standard	JIS standard
EN-JS1060	EN-GJS-600-3	-	FCD600-3
1.1191	C45E	-	S45C
1.2379	X155CrVMo12-1	AISI D2	-
1.4301	X5CrNi18-10	AISI 304 / TP 304	SUS304
1.4305	X8CrNiS18-9	AISI 303	SUS303
1.4435	X2CrNiMo18-14-3	- (also not 316L)	-
1.4404	X2CrNiMo17-12-2	- (also not 316L)	-

4 Tumbling / vibratory grinding

Tumbling or vibratory grinding is a mechanical/chemical procedure for surface processing which is used primarily for metal workpieces. The workpieces, together with the abrasive media (known as chips), water and a washing solution (compound), are placed as bulk material in a container which is lined with rubber or polyurethane.

The movement of the container causes a relative movement between workpieces and chips which, in turn, results in removal of material from workpiece surfaces and in particular from workpiece edges.

Tumbling is used for the following procedures: deburring, edge rounding, grinding, smoothing, polishing, degreasing, descaling, matting and densifying.

4.1 Purpose and field of application

This part of the instructions applies in general to vibratory finishing or tumbling.

Caution: Tumbling never replaces the cleaning/washing procedure.

4.2 Tumbling / vibratory grinding requirements

After tumbling, parts which are used in vacuum (labelled as "cleaned for vacuum use") must be completely free of any adhesive residues and other materials such as zinc, tin or organic/inorganic substances.

Technical Specifications / Instructions for Suppliers

4.3 Specifications in the documents

Vibratory finishing or tumbling are specified as mandatory by the symbol shown below:



or, on older drawings:

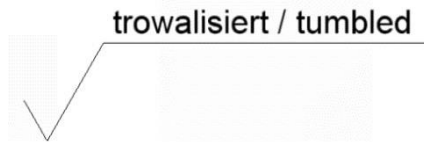

5 Sandblasting

5.1 Purpose and field of application

The following instructions apply to all blasting work on parts used in vacuum.

5.2 Sandblasting requirements

- Blasting work may only be carried out with systems and blasting media when there is proof available that the aforementioned have only been used for stainless steel.
- Constant checks and cleaning/replacement of the blasting media (e.g. reusable blasting media) must be carried out and proof of these procedures must be made available.
- Under no circumstances should there be zinc, tin, rust or organic/silicone-containing residues in the system used or in the blasting material.
- Wash the blasted parts after the blasting procedure.
- Keep warping to a minimum during the blasting procedure.

5.3 Specifications in the documents

Sandblasted (symbol in drawing)

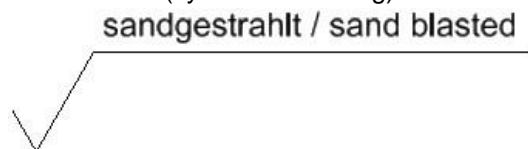

Bead blasted (symbol in drawing)

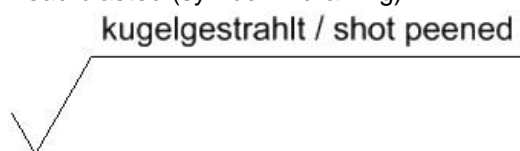

Parts which should NOT be subjected to blasting are marked with the following symbol:



5.4 Process specifications

Processes which have been required as standard in Oerlikon Balzers Coating Services production documents and which are currently in use:

Technical Specifications / Instructions for Suppliers

Previous descriptions in drawings	Descriptions in drawings from 2004 onwards (identical with the description on the left)
High-grade corundum blasting, corundum blasting, raw corundum blasting	Sandblasted
Glass bead blasting, glass bead blasted, bead blasted, slurry blasted	Bead blasted

Specifications	Sandblasted (procedure: compressed air blasting)		Bead blasted (procedure: compressed air blasting)
	High pressure sandblasting	Low-pressure sandblasting	
Field of application	For thick-walled components	For thin-walled components	For deburring, cleaning surfaces (e.g. after welding) and optical improvement (in the process, the surface is slightly densified).
Blasting material	Corundum 54 / AL ₂ O ₃	Corundum 54 / AL ₂ O ₃	SiO ₃
Particle size	250 – 350 [µm]	250 – 350 [µm]	200 – 300 [µm]
Jet pressure	3 - 4 [bar] Dependent on wall strength of component Warning: evenness tolerances / check for warping	1 - 3 [bar] Dependent on wall strength of component Warning: evenness tolerances / check for warping	1 - 4 [bar] Dependent on wall strength of component Warning: evenness tolerances / check for warping
Distance between jet nozzle and workpiece	10 – 20 [cm]	20 – 30 [cm]	10 – 30 [cm]
Angle of jet to workpiece	70° – 90°	30° – 50°	45° – 90°

Alternative procedures which fulfill the specifications listed above are accepted.

Technical Specifications / Instructions for Suppliers

6 Welding

Welding is considered to be “the permanent joining of components through the application of heat, with or without the use of filler metals.” The necessary welding energy is applied from an external source. Welding additives, such as shielding gases, welding powder or pastes, can facilitate the welding or be required to even make it possible. Welding can take place through the introduction of heat until the working material melts or through introduction of heat into the workpiece.

6.1 Purpose and field of application

The following instructions apply in general to all welding work on parts which are used inside or outside the vacuum.

6.2 Welding process specification (reference number)

For welding symbols where no indication of the welding process is given, it is left to the supplier to decide which welding process is to be used (EN ISO 5817 Quality Level C is to be used as a guideline in all cases).

6.3 Welding requirements

The quality requirements are divided into 3 classes

6.3.1 Class 1: General specifications

E.g. covers, shielding, mounting brackets, housings, holder parts, carousel loading platforms etc. The weld quality must be executed according to EN ISO 5817 Quality Level C, and for aluminium according to EN ISO 10042 Quality Level C

Specifications in the documents:

Unless defined otherwise, all welds are to be executed according to EN ISO 5817 Quality Level C, and for aluminium according to EN ISO 10042 Quality Level C.

6.3.2 Class 2: Products with higher welding process quality requirements

E.g. chambers, systems – frame, transport – auxiliary devices, safety supports on carousel loading platforms etc.

- Quality requirements for welds according to the EN ISO 3834-2 standard. All optional requirements from Annex A of the EN ISO 3834-1 standard must be implemented.
- The supplier must also provide evidence that the welding work was conducted by specialist personnel certified according to EN ISO 9606-1.
- The quality of the welds complies with EN ISO 5817 (Fusion-welded joints in steel, nickel, titanium and their alloys) Quality Level C.
- For aluminium welds, the quality complies with EN ISO 10042 Quality Level C.

Technical Specifications / Instructions for Suppliers

Specifications in the documents:

Unless defined otherwise, all welds are to be executed according to EN ISO 5817 Quality Level C, and for aluminium according to EN ISO 10042 Quality Level C.

Additional requirements in accordance with class 2 from the document "Instructions for Suppliers".

6.3.3 Class 3: Specifications for load-lifting equipment

All specifications for load-lifting equipment are defined in document 80091533. This document is included as a specification document with every load-lifting product.

Specifications in the documents:

Manufacturing and inspection in accordance with document 80091533

7 Cleaning**7.1 Purpose and field of application**

The following cleaning instructions ensure that all Oerlikon Balzers Coating Services products are subjected to a surface cleaning procedure which complies with the requirements.

A distinction is made between the following cleaning classes:

- a) **General cleaning class** for parts which are not used in vacuum
- b) **Process parts** which are used inside the system under vacuum or which come into contact with the substrate or other vacuum parts inside or outside the system.

The instructions apply to all prototype products, serial products, components and individual parts, independent of the manufacturing site.

7.2 Cleaning requirements**7.2.1 a) General cleaning class****Requirements:**

General cleaning procedures to keep the area immediately around the assembly clean, e.g. frames, cable conduits, casings etc.

Cleaning procedure:

State-of-the-art wet cleaning on a water basis and subsequent drying.

Specifications in the documents:

These specifications are generally valid for all parts provided that no stricter measures are specified in the drawings/specs.

7.2.2 b) Cleaning process parts**Requirements:**

In order to achieve high-quality vacuum, it is extremely important to clean process parts. In particular, organic contamination (grease, oil) influences vacuum properties and can destroy or impair the quality of the coating.

Inorganic contamination (dust, powder, corrosion residue) produces a high number of particles which can influence and increase the pumping time.

The following requirements for cleanliness must be fulfilled:

- grease-free
- dry
- free from cleaning and manufacturing residues
- free from dust and particles

Technical Specifications / Instructions for Suppliers

7.3 Specifications in the drawings

vakuumgerecht gereinigt /
cleaned for vacuum use

**7.4 Process specifications****Cleaning procedure:**

Use state-of-the-art, multi-stage wet cleaning on a water basis combined with subsequent oven drying. Adhere to the relevant legal, country-specific regulations and standards when using solvents and cleaning agents.

After removal from the cleaning bath, always wear clean, lint-free hand protection/synthetic gloves to handle the product.

Cleaned products must be checked for manufacturer marking and/or labelling. These must be removed with acetone or any suitable diluter.

After the products have cooled down to ambient temperature, shrink-wrap them immediately in plastic foil or wrap them in a hermetic package.

Traceability of supplier's cleaning process

To ensure that the supplier complies with the high cleaning requirements for vacuum parts, the supplier must provide descriptions of the cleaning processes carried out. Evidence must be supplied that the required bath analyses have been performed and recorded in writing.

Wipe test

Tools: White, lint-free cloth and isopropanol

Work instructions: Wipe off the test piece with a lint-free cloth which has been moistened with alcohol.

Test passed: No discolouration and no particles on the cloth.

8 Mounting for vacuum use**8.1 Purpose and field of application**

The following assembly instructions ensure that all Oerlikon Balzers Coating Services products are subjected to an assembly procedure which complies with the requirements.

8.2 Mounting requirements

In order to achieve high-quality vacuum, it is important to use only clean process parts as described in Chapter Fehler! Verweisquelle konnte nicht gefunden werden..

These parts are grease-free, dry, free from cleaning and manufacturing residues and free from dust and particles. The mounting process shall ensure the same cleanliness of these parts and also the complete assembly.

8.3 Specifications in the drawing

vakuumgerechte Montage/
mounted for vacuum use



Technical Specifications / Instructions for Suppliers

8.4 Mounting specifications

To ensure the cleanliness of the process parts and assemblies the following requirements must be met:

Handling:

Parts must not be touched with bare hands or dirty gloves. Always use clean and dry textile gloves.

Tools:

Tools shall be cleaned and free from oil, grease and liquids.

Working area:

Working areas shall be protected against critical areas where machining, painting, lubricating and other contaminating work is done. This can be realized by movable walls, curtains or separate rooms.

There shall be cleanliness oriented regulations within the working area and regarding material and personal transport towards other areas.

No special air treatment is necessary.

(see also definition of clean zone SaS1 acc. VDA 19.2)

Parts:

After the assemblies are mounted, they shall be shrink-wrapped in plastic foil or wrapped in a hermetic package.

9 Bake-out

9.1 Purpose and field of application

To reduce outgassing in vacuum, it may be necessary to bake out certain products prior to the actual process. If this procedure is required, it will be indicated in the drawing or in the specifications. The bake-out parameters are defined in the requirements accordingly.

9.2 Specifications in the documents

Ausheizen im Vakuum bei:	450 °C
Degased in vacuum atmosphere at:	
Druck:	<1 x10 ⁻² mbar
Pressure:	
Haltezeit (nach Erreichen der Kerntemperatur):	2 h
Dwell time (after reaching the core temperature):	

} The parameters shown are examples.

9.3 Bake out process

Prior to the bakeout process, clean the parts to prepare them for vacuum conditions in accordance with the instructions in Chapter 3.

Then carry out the bake-out using the specified parameters. The temperature hold-time commences once the required bake-out temperature is reached. Let the oven temperature sink to below 100°C before you open the oven. (Copper ≤ 80°C).

Wear clean, lint-free gloves to handle products when they are removed from the oven.

After the products have cooled down to ambient temperature, shrink-wrap them immediately in plastic foil or wrap them in a hermetic package.

10 Packaging

Products used in the system's vacuum chamber and products which come into contact with other vacuum parts inside or outside the system are marked in the documentation/specifications by the cleaning or bake-out symbol.

After these procedures, it is extremely important to protect the products against recontamination.

Technical Specifications / Instructions for Suppliers

For this reason, always use clean, lint-free gloves or cloths to protect the products when you handle them for further processing. Ensure that the products are wrapped in protective packaging immediately after the procedures in compliance with the relevant instructions.

See Packaging Instructions 300063400/OP1/000/02 and BB466457-V for information regarding labelling and transport-suitable packaging.

10.1 References to further specification documents

300063400/OP1/000/02 and BB466457-V	Packaging Instructions
BB852550-V	Instructions for pretreating Durotenax parts
BB852551-V	Instructions for pretreating O-rings
BB489090-V	Labels with serial numbers
80091533	Requirements for suppliers for manufacturing load-lifting equipment

OC Oerlikon Balzers Ltd. Iramali 18 P.O. Box 1000 LI-9496 Balzers Liechtenstein	Tel. +423 388 75 00 Fax +423 388 54 19 info.coating@oerlikon.com www.oerlikon.com/balzers	Principal Office: LI-9496 Balzers Liechtenstein VAT-No.: 50118	District Court: LI-9490 Vaduz Liechtenstein Trade Reg. No.: FL-0002.019.230-3
--	---	---	--